

# GABAR HEALTH — SCIENCES —



**Office Address:**  
One Hartsfield Center  
Atlanta, GA 30354

**Phone Number:**  
470-737-9424 main  
470-737-9431 fax

[www.gabarhealthsciences.com](http://www.gabarhealthsciences.com)

## DISPOSABLE UNIVERSAL PACK

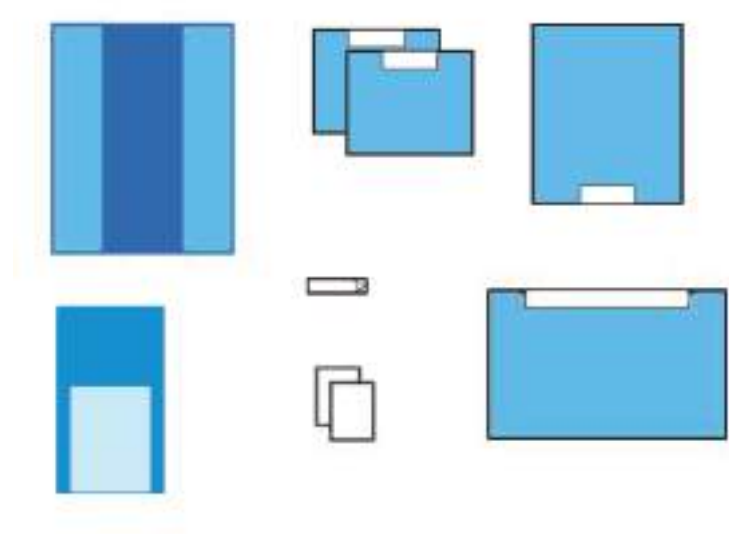

| Specification    | Size(cm)  | Qty  | Material |
|------------------|-----------|------|----------|
| Side Drape       | 75x90cm   | 2pcs | SMS+Tape |
| Bottom Drape     | 150x180cm | 1pc  | SMS+Tape |
| Top Drape        | 150x240cm | 1pc  | SMS+Tape |
| OP-Tape          | 10x50cm   | 1pc  | SMS+Tape |
| Back Table Cover | 150x190cm | 1pc  | PE+PP    |
| Mayo stand Cover | 80x140cm  | 1pc  | PE+PP    |
| Hand Tow         | 30x40cm   | 2pcs | Spunlace |

\*Customized design is available

## DISPOSABLE CESAREAN PACK

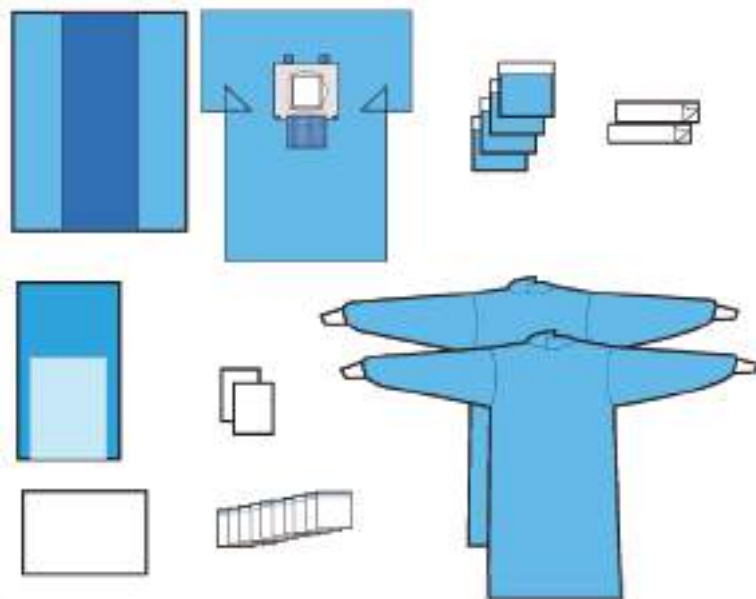

| Specification                              | Size(cm)      | Qty   | Material  |
|--|---------------|-------|-----------|
| Back Table Cover                           | 150x190cm     | 1pcs  | PP+PE     |
| Cesarean Drape with fluid collection pouch | 260/200x330cm | 1pc   | SMS       |
| Utility Drape                              | 60x60cm       | 4pcs  | SMS +Tape |
| OP-Tape                                    | 10x50cm       | 2pcs  | SMS+Tape  |
| Mayo Stand Cover                           | 80x140cm      | 1pc   | PE+PP     |
| Hand Towel                                 | 30x40cm       | 2pcs  | Spunlace  |
| Baby Wrapper                               | 80x120cm      | 1pc   | Spunlace  |
| X-ray GauzeSwab                            | 10x10cm-8P    | 10pcs | Cotton    |
| Standard Surgical Gown                     | L             | 2pcs  | SMS       |

\*Customized design is available

# DISPOSABLE DELIVERY PACK

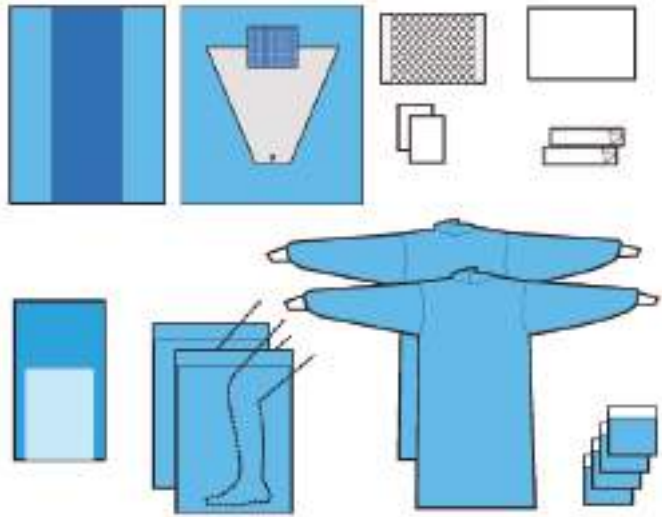

| Specification                                   | Size(cm)  | Qty  | Material  |
|---|-----------|------|---|
| Back Table Cover                                | 150x190cm | 1pc  | PP+PE   |
| Standard Surgical Gown                          | L         | 2pcs | SMS   |
| OP-Tape   | 10x50cm   | 2pcs | SMS+Tape  |
| Under Buttock Drape With Fluid Collection Pouch | 110x120cm | 1pc  | SMS,PE  |
| Legging   | 35x90cm   | 2pcs | SMS   |
| Dignity Sheet                                   | 60x90cm   | 1pc  | 5 layer with absorption of 1,5 litres:<br>1st layer: non woven<br>2nd layer: tissue paper<br>3rd layer: fluff pulp mix super<br>Absorbent polymer(sap)<br>4th layer :tissue paper<br>5th layer. pe film |
| Utility Drape                                   | 60x60cm   | 4pcs | SMS+Tape  |
| Mayo Stand Cover                                | 80x140cm  | 1pc  | PE+PP   |
| Hand Towel                                      | 30x40cm   | 2pcs | Spunlace  |
| Baby Wrapper                                    | 120x80cm  | 1pc  | Spunlace  |

\*Customized design is available

# DISPOSABLE ANGIOGRAPHY PACK

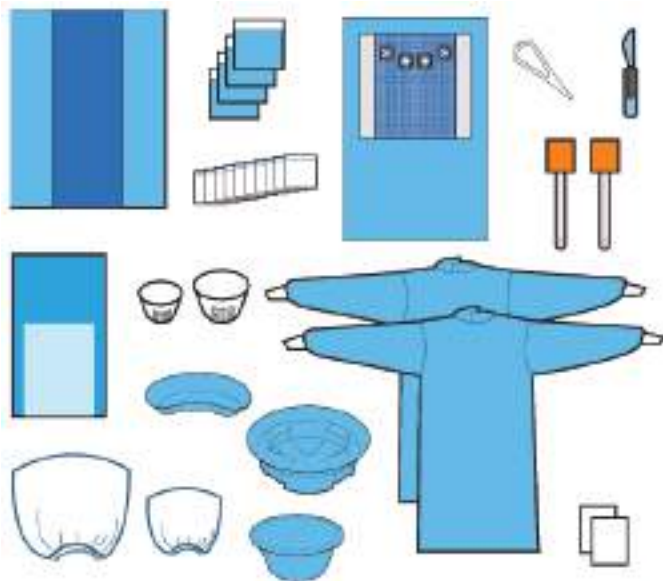

| Specification            | Size(cm)   | Qty   | Material |
|--------------------------|------------|-------|----------|
| Back Table Cover         | 150x190 cm | 1pc   | PP+PE    |
| Angiography Drape        | 180x350 cm | 1pc   | SMS      |
| Utility Drape            | 60x60 cm   | 4pcs  | SMS+Tape |
| Standard Surgical Gown L | L          | 2pcs  | SMS      |
| X-ray Gauze Swab         | 10x10cm-8P | 10pcs | Cotton   |
| Fluoroscoov Cover        | 100x100cm  | 1pc   | PE       |
| Fluoroscopy Cover        | 90x150cm   | 1pc   | PE       |
| Scalpel with Handle      | No.11      | 1pc   | /        |
| Tweezer                  | 12.5cm     | 1pc   | Plastic  |
| Soonae Brush             | 4x4cm      | 2pcs  | /        |
| Bowl Guidewire Tabs      | 1000ml     | 1pc   | Plastic  |
| Kidney Bowl              | 500ml      | 1pc   | Plastic  |
| Medicine Cup             | 60ml       | 1pc   | Plastic  |
| Medicine Bowl            | 100ml      | 1pc   | Plastic  |
| Medicine Bowl            | 13.5x6.5cm | 1pc   | Plastic  |
| Mayo Stand Cover         | 80x140cm   | 1pc   | PP+PE    |
| Hand Towel               | 30x40cm    | 2pcs  | Spunlace |

\*Customized design is available

## DISPOSABLE CRANIOTOMY PACK

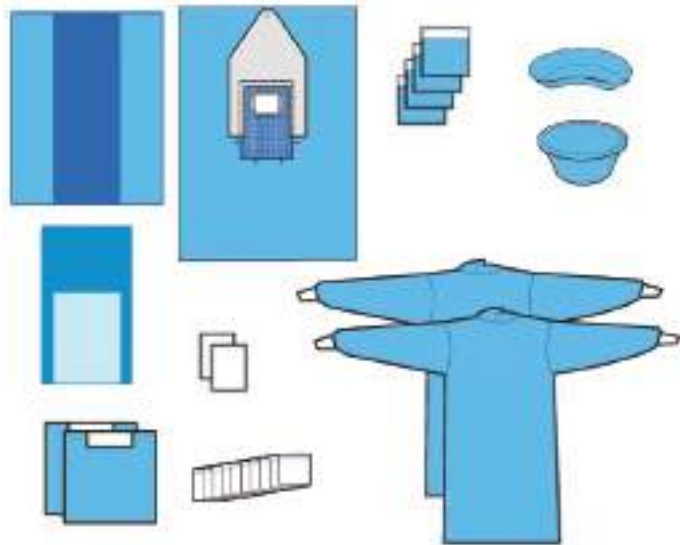

| Specification          | Size(cm)   | Qty   | Material |
|------------------------|------------|-------|----------|
| Back Table Cover       | 150x190cm  | 1pc   | PP+PE    |
| Craniotomy Drape       | 200x320cm  | 1pc   | SMS      |
| Utility Drape          | 60x60an    | 4pcs  | SMS+Tape |
| Standard Surgical Gown | L          | 2pcs  | SMS      |
| X-ray Gauze Swab       | 10x10cm-8P | 10pcs | Cotton   |
| Mayo Stand Cover       | 80x140cm   | 1pc   | PP+PE    |
| Medium Drape           | 150x150cm  | 2pcs  | SMS+Tape |
| Kidney Bowl            | 500ml      | 1pc   | Plastic  |
| Medicine Bowl          | 400ml      | 1pc   | Plastic  |
| Hand Towel             | 30x40cm    | 2pcs  | Spunlace |

\*Customized design is available

## DISPOSABLE SPINE PACK

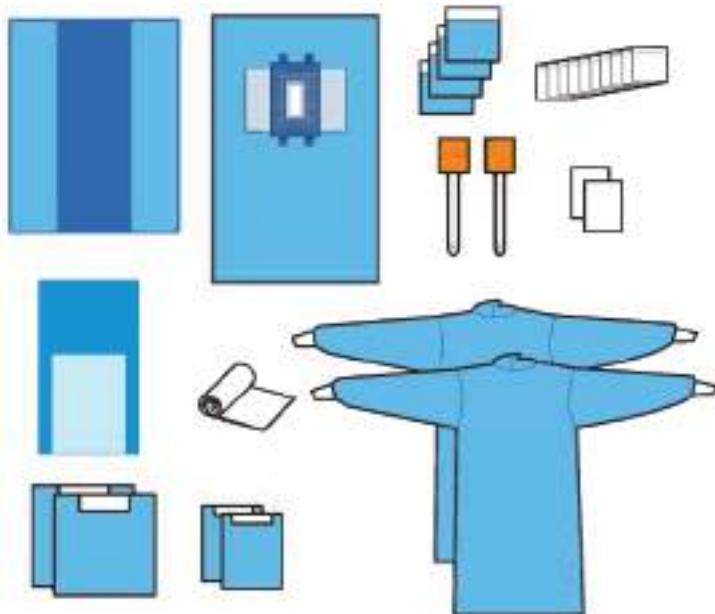

| Specification          | Size(cm)   | Qty   | Material |
|------------------------|------------|-------|----------|
| Back Table Cover       | 150x190 cm | 1pc   | PP+PE    |
| Spine Drape            | 200x320 cm | 1pc   | SMS      |
| Utility Drape          | 60x60cm    | 4pcs  | SMS+Tape |
| Standard Surgical Gown | L          | 2pcs  | SMS      |
| X-ray Gauze Swab       | 10x10cm-8P | 10pcs | Cotton   |
| Mayo Stand Cover       | 80x140cm   | 1pc   | PP+PE    |
| Elastic Bandage        | 15x450cm   | 1pc   | SMS      |
| Medium Drape           | 150x150cm  | 2pcs  | SMS+Tape |
| Side Drape             | 80x100cm   | 2pcs  | SMS      |
| Sponge Brush           | 4x4cm      | 2pcs  | /        |
| Hand To                | 30x40cm    | 2pcs  | Spunlace |

\*Customized design is available

## DISPOSABLE THYROID PACK

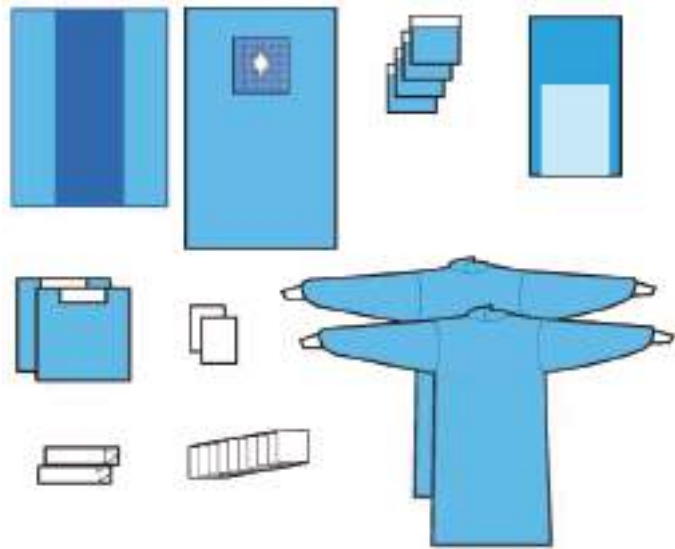

| Specification          | Size(cm)   | Qty   | Material |
|------------------------|------------|-------|----------|
| Back Table Cover       | 150x190 cm | 1pc   | PP+PE    |
| Thyroid Drape          | 200x320cm  | 1pc   | SMS      |
| Mayo Stand Cover       | 80x140cm   | 1pc   | PP+PE    |
| Utility Drape          | 60x60cm    | 4pcs  | SMS+Tape |
| OP-Tape                | 10x10cm    | 2pcs  | SMS+Tape |
| Medium Drape           | 150x150cm  | 2pcs  | SMS+Tape |
| Standard Surgical Gown | L          | 2pcs  | SMS      |
| Hand Towel             | 30x40cm    | 2pcs  | Spunlace |
| Gauze Swab             | 10x10cm-8p | 10pcs | Cotton   |

\*Customized design is available

## DISPOSABLE CHEST PACK

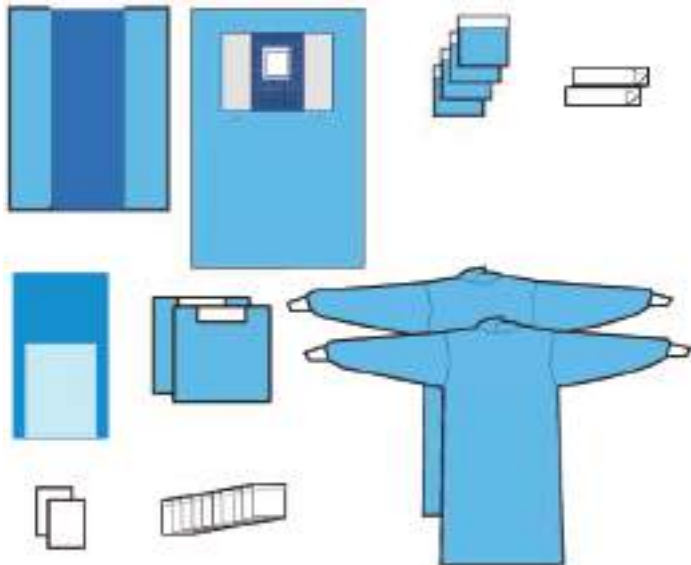

| Specification          | Size(cm)   | Qty   | Material |
|------------------------|------------|-------|----------|
| Back Table Cover       | 150x190cm  | 1pc   | PP+PE    |
| Chest Drape            | 200x300cm  | 1pc   | SMS      |
| Mayo Stand Cover       | 80x140cm   | 1pc   | PP+PE    |
| Utility Drape          | 60x60cm    | 4pcs  | SMS+Tape |
| OP-Tape                | 10x50cm    | 2pcs  | SMS+Tape |
| Medium Drape           | 150x150cm  | 2pcs  | SMS+Tape |
| Standard Surgical Gown | L          | 2pcs  | SMS      |
| Hand Towel             | 30x40cm    | 2pcs  | Spunlace |
| X-ray Gauze Swab       | 10x10cm-8p | 10pcs | Cotton   |

\*Customized design is available

## DISPOSABLE LAPAROTOMY PACK

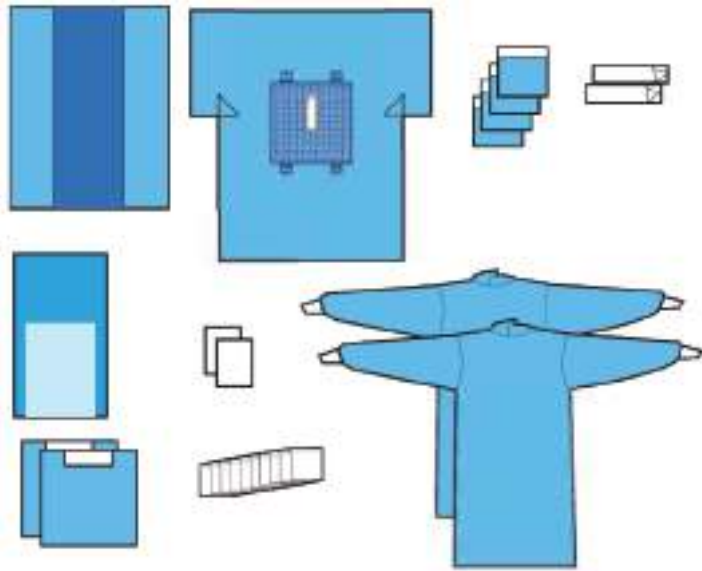

| Specification          | Size(cm)      | Qty   | Material |
|------------------------|---------------|-------|----------|
| Back Table Cover       | 150x190cm     | 1pc   | PP+PE    |
| Laparotomy Drape       | 260/200x330cm | 1pc   | SMS      |
| Mayo Stand Cover       | 80x140cm      | 1pc   | PP+PE    |
| Utility Drape          | 60x60cm       | 4pcs  | SMS+Tape |
| OP-Tape                | 10x50cm       | 2pcs  | SMS+Tape |
| Medium Drape           | 150x150cm     | 2pcs  | SMS+Tape |
| Standard Surgical Gown | L             | 2pcs  | SMS      |
| HandTONel              | 30x40cm       | 2pcs  | Spunlace |
| X-ray Gauze Swab       | 10x10cm-8p    | 10pcs | Cotton   |

\*Customized design is available

## DISPOSABLE T.U.R. PACK

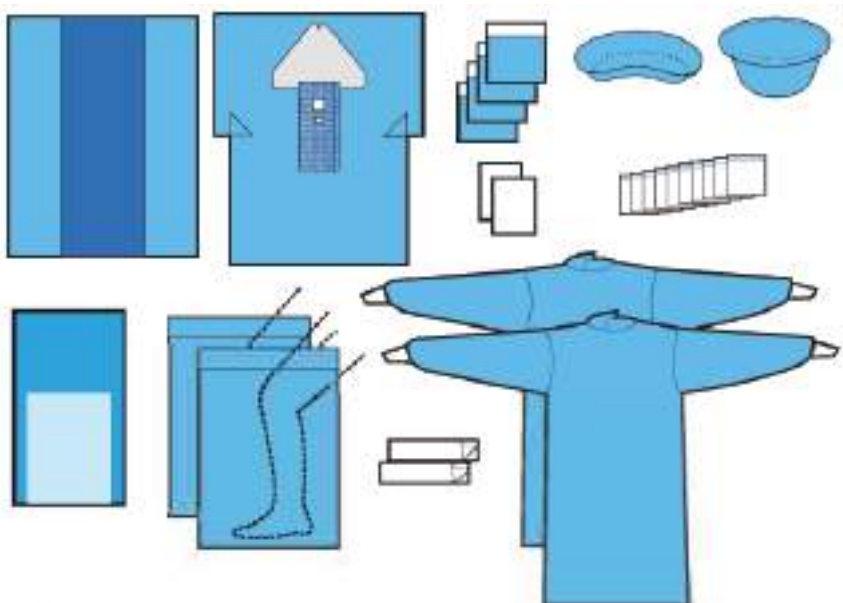

| Specification          | Size(cm)      | Qty   | Material |
|------------------------|---------------|-------|----------|
| Back Table Cover       | 150x190cm     | 1pc   | PP+PE    |
| TU.R. Drape            | 200/170x240cm | 1pc   | SMS      |
| Utility Drape          | 60x60cm       | 4pcs  | SMS+Tape |
| OP-Tape                | 10x50cm       | 2pcs  | SMS+Tape |
| Standard Surgical Gown | L             | 2pcs  | SMS      |
| X-ray Gauze Swab       | 10x10cm-8P    | 10pcs | Cotton   |
| Mayo Stand Cover       | 80x140cm      | 1pc   | PP+PE    |
| Legging                | 35x90cm       | 2pcs  | SMS      |
| Kidney Bowl            | 250ml         | 1pc   | Plastic  |
| Medicine Bowl          | 500ml         | 1pc   | Plastic  |
| HandTONel              | 30x40cm       | 2pcs  | Spunlace |

\*Customized design is available

# DISPOSABLE EXTREMITY PACK

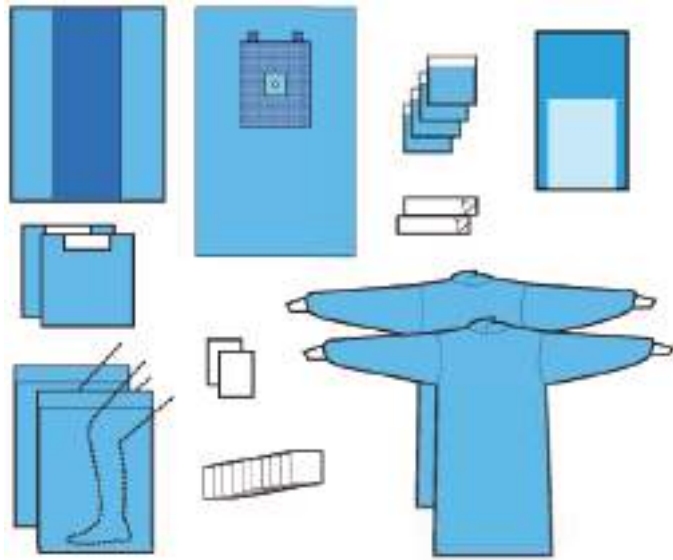

| Specification          | Size(cm)   | Qty   | Material |
|------------------------|------------|-------|----------|
| Back Table Cover       | 150x190cm  | 1pc   | PP+PE    |
| Extremity Drape        | 190x300cm  | 1pc   | SMS      |
| Mayo Stand Cover       | 80x140cm   | 1pc   | PP+PE    |
| Utility Drape          | 60x60cm    | 4pcs  | SMS+Tape |
| OP-Tape                | 10x50cm    | 2pcs  | SMS+Tape |
| Medium Drape           | 150x150cm  | 2pcs  | SMS+Tape |
| Standard Surgical Gown | L          | 2pcs  | SMS      |
| Hand Towel             | 30x40cm    | 2pcs  | Spunlace |
| Gauze Swab             | 10x10cm-8p | 10pcs | Cotton   |
| Legging                | 35x90cm    | 2pcs  | SMS      |

\*Customized design is available

# DISPOSABLE OPHTHALMOLOGY PACK

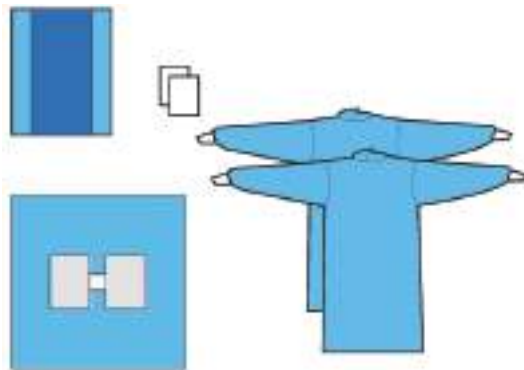

| Specification          | Size(cm)  | Qty  | Material |
|------------------------|-----------|------|----------|
| Wrapper                | 90x100cm  | 1pc  | PP+PE    |
| Ophthalmology Drape    | 100x100cm | 1pc  | SMS      |
| Hand Towel             | 30x40cm   | 2pcs | Spunlace |
| Standard Surgical Gown | L         | 2pcs | SMS      |

\*Customized design is available

# DISPOSABLE DENTAL PACK

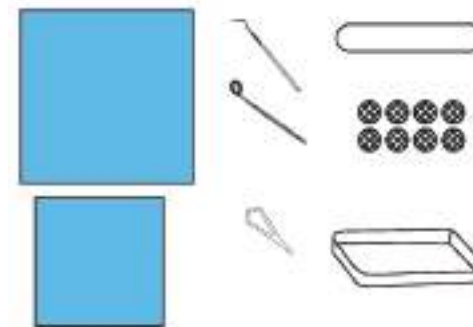

| Specification         | Size(cm) | Qty  | Material |
|-----------------------|----------|------|----------|
| Probe                 | 17cm     | 1pc  | Metal    |
| Odontoscope           | 16cm     | 1pc  | /        |
| Spatula               | 15cm     | 1pc  | /        |
| Dental Operation Drap | 50x50cm  | 1pc  | SPE      |
| Medical Tray          | /        | 1pc  | Plastic  |
| Wrapper               | 40x45cm  | 1pc  | SPE      |
| Medical Cotton Ball   | 0.9g     | 8pcs | Cotton   |
| Tweezers              | 16cm     | 1pc  | Metal    |

\*Customized design is available

# DISPOSABLE SURGICAL DRAPES

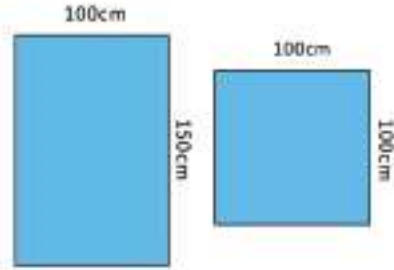

## General Drape

| Specification | Size(cm)             | Qty | Material |
|---------------|----------------------|-----|----------|
| General Drape | 100x100cm, 100x150cm | 1pc | SMS      |
|               | 75x75cm, 75x90cm     |     | SMS+Tape |
|               | 45x70cm, 100x120cm   |     | PE+PP    |
|               | 100x150cm, 120x150cm |     |          |
|               | 150x180cm, 200       |     |          |

\*Customized design is available

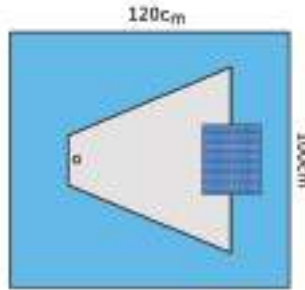

## Under Buttocks Drape

| Specification        | Size(cm)  | Qty | Material |
|----------------------|-----------|-----|----------|
| Under Buttocks Drape | 100x120cm | 1pc | SMS      |
| With Pouch           | 110x120cm |     | PE+PP    |



Reinforced Area : 25x30cm  
Fluid Collection Pouch : 70x80cm

\*Customized design is available

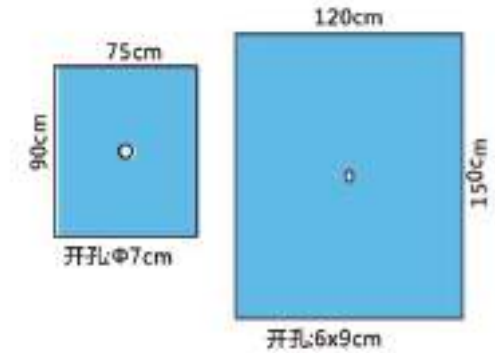

## Fenestrated Drape

| Specification     | Size(cm)              | Qty | Material     |
|-------------------|-----------------------|-----|--------------|
| Fenestrated Drape | 75x90cm(hole 7cm)     | 1pc | SMS<br>PE+PP |
|                   | 75x90cm(hole 10cm)    |     |              |
|                   | 150x120cm(hole:6x9cm) |     |              |
|                   | 60x50cm(hole 7cm)     |     |              |
|                   | 80x90cm(hole 7cm)     |     |              |
|                   | 160x120cm(hole10cm)   |     |              |

\*Customized design is available

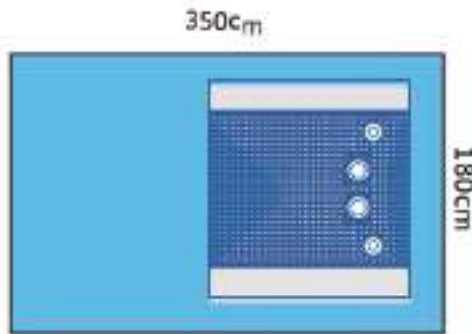

## Cardiovascular Drape

| Specification        | Size(cm)      | Qty | Material |
|----------------------|---------------|-----|----------|
| Cardiovascular Drape | 180x350cm     | 1pc | SMS      |
|                      | 260/200x330cm |     | PE+PP    |



Hole Size: 12cm 14cm Reinforced Area : 100x130cm Fluid Collection Pouch : 25x130cm

\*Customized design is available

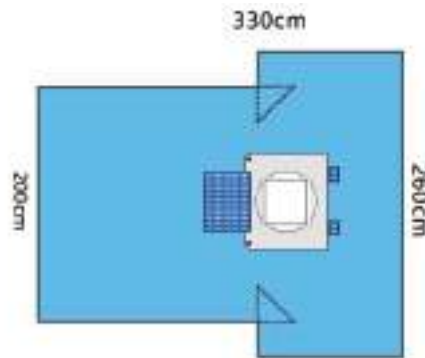

## Cesarean Drape

| Specification  | Size(cm)      | Qty | Material |
|----------------|---------------|-----|----------|
| Cesarean Drape | 260/200x330cm | 1pc | SMS      |
|                | 310/210x320cm |     | PE+PP    |



Hole Size : 30x30cm Reinforced Area : 50x40cm/Fluid Collection Pouch : 80x70cm

\*Customized design is available

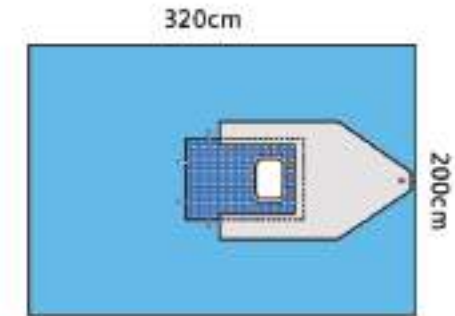

## Craniotomy Drape

| Specification    | Size(cm)  | Qty | Material     |
|------------------|-----------|-----|--------------|
| Craniotomy Drape | 200x320cm | 1pc | SMS<br>PE+PP |



Hole Size : 28x20cm Reinforced Area : 70x48cm Fluid Collection Pouch : 114x70cm

\*Customized design is available



# DISPOSABLE SURGICAL DRAPES

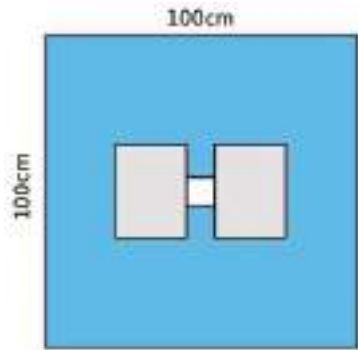

Ophthalmology Drape

| Specification       | Size(cm)             | Qty | Material     |
|---------------------|----------------------|-----|--------------|
| Ophthalmology Drape | 25x45cm, 50x50cm     | 1pc | SMS<br>PE+PP |
|                     | 100x100cm, 100x120cm |     |              |
|                     | 120x140cm, 140x140cm |     |              |
|                     | 150x200cm            |     |              |



  
 SMS Fluid Collection Pouch  
 Hole Size : 9x9cm  
 Fluid Collection Pouch : 30x26cm  
 \*Customized design is available

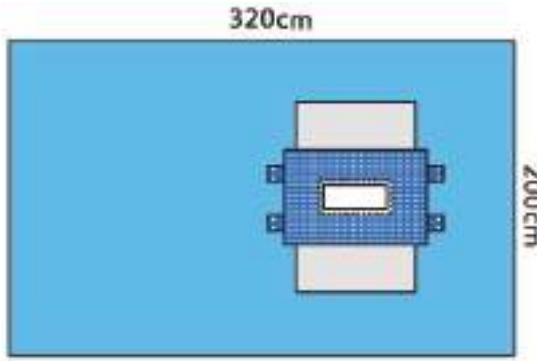

Spine Drape

| Specification | Size(cm)  | Qty | Material     |
|---------------|-----------|-----|--------------|
| Spine Drape   | 200x320cm | 1pc | SMS<br>PE+PP |



  
 SMS Reinforced Area Fluid Collection Pouch  
 Hole Size : 35x15cm  
 Reinforced Area : 90x60cm  
 Fluid Collection Pouch : 75x30  
 \*Customized design is available

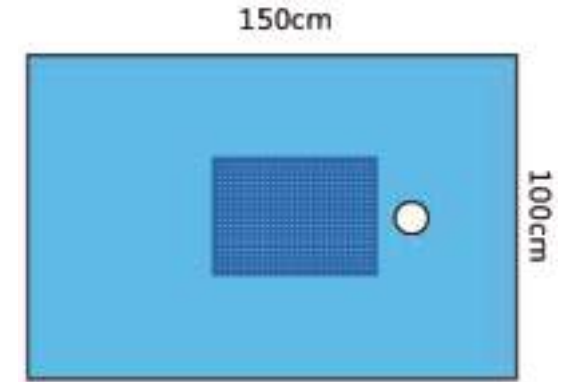

E.N.T. Drape

| Specification | Size(cm)  | Qty | Material     |
|---------------|-----------|-----|--------------|
| E.N.T. Drape  | 100x50cm  | 1pc | SMS<br>PE+PP |
|               | 100x150cm |     |              |
|               | 150x170cm |     |              |



  
 SMS Reinforced Area  
 Hole Size : 10cm / Reinforced Area : 50x36cm  
 \*Customized design is available

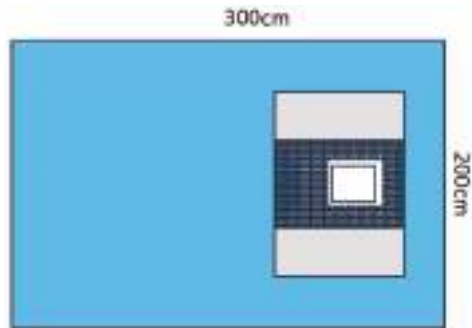

Chest Drape

| Specification | Size(cm)  | Qty | Material     |
|---------------|-----------|-----|--------------|
| Chest Drape   | 200x300cm | 1pc | SMS<br>PE+PP |



  
 SMS Reinforced Area Fluid Collection Pouch  
 Hole Size : 30x25 cm  
 Reinforced Area : 90x60cm  
 Fluid Collection Pouch : 90x34cm  
 Surgical membrane : 35x30cm  
 \*Customized design is available

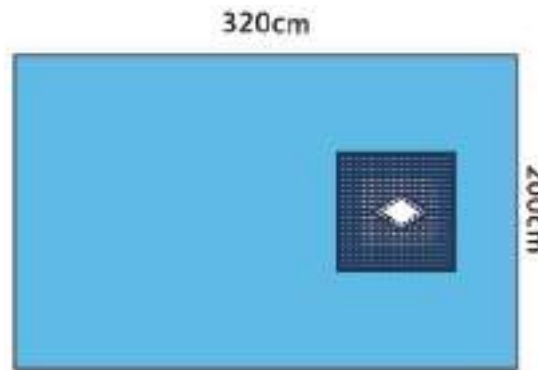

Thyroid Drape

| Specification | Size(cm)  | Qty | Material     |
|---------------|-----------|-----|--------------|
| Thyroid Drape | 200x320cm | 1pc | SMS<br>PE+PP |



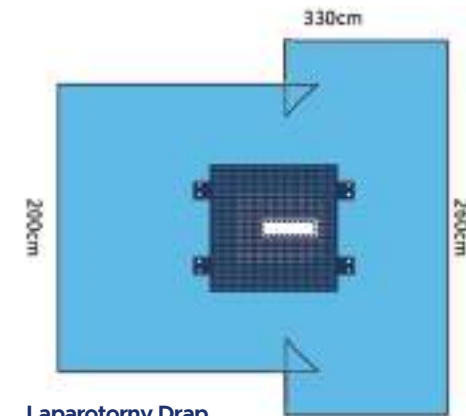

  
 SMS Reinforced Area  
 Hole Size : 13 cm  
 Reinforced Area : 60x60cm  
 \*Customized design is available



Laparotomy Drape

| Specification    | Size(cm)      | Qty | Material     |
|------------------|---------------|-----|--------------|
| Laparotomy Drape | 260/200x33cm  | 1pc | SMS<br>PE+PP |
|                  | 290/200x310cm |     |              |

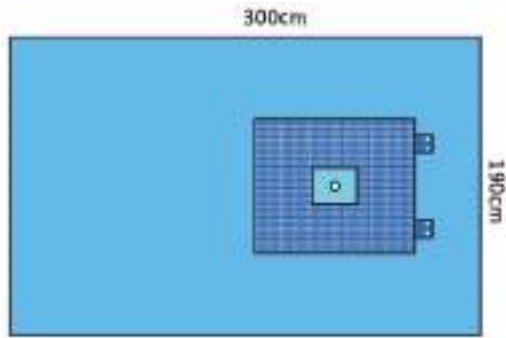

  
 SMS Reinforced Area  
 Hole Size : 30x10cm  
 Reinforced Area : 75x75cm  
 Ear piece : 10x10cm  
 \*Customized design is available

# DISPOSABLE SURGICAL DRAPES



**Extremity Drape**

| Specification   | Size(cm)      | Qty | Material |
|-----------------|---------------|-----|----------|
| Extremity Drape | 190x300cm     | 1pc | SMS      |
|                 | 270/160x300cm |     | PE+PP    |



Hole Size : 25x20cm / Softfilm opening : 5cm / Reinforced Area : 90x75cm  
\*Customized design is available

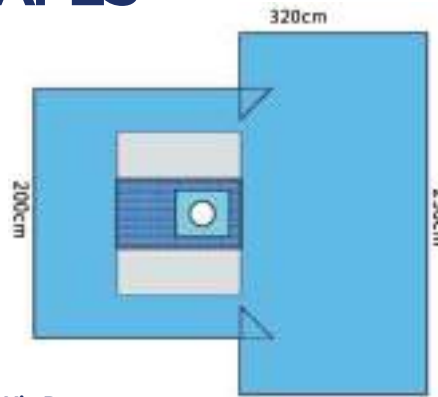

**Hip Drape**

| Specification | Size(cm)      | Qty | Material |
|---------------|---------------|-----|----------|
| Hip Drape     | 290/200x320cm | 1pc | SMS      |
|               | 325/270x330cm |     | PE+PP    |



Soft film opening : 20cm, 38x43cm  
Reinforced Area : 55x100cm / Fluid Collection Pouch : 38x100cm  
\*Customized design is available

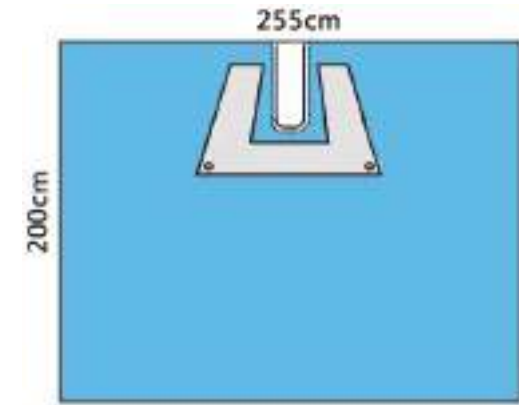

**Shoulder Drape**

| Specification  | Size(cm)  | Qty | Material     |
|----------------|-----------|-----|--------------|
| Shoulder Drape | 255x200cm | 1pc | SMS<br>PE+PP |



Hole Size : 15x45cm  
PFluid Collection Pouch : 114x55cm  
\*Customized design is available

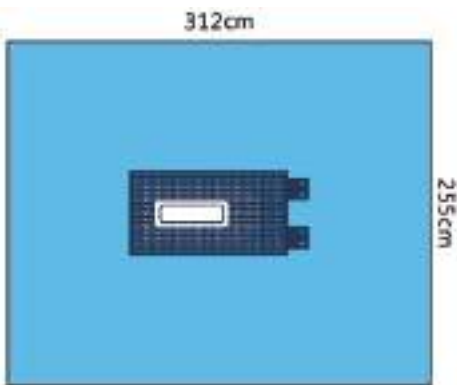

**Lithotomy Drape**

| Specification   | Size(cm)  | Qty | Material     |
|-----------------|-----------|-----|--------------|
| Lithotomy Drape | 255x312cm | 1pc | SMS<br>PE+PP |



Hole Size : 10x30cm  
Reinforced Area : 40x75cm  
Ear piece : 10x10cm  
\*Customized design is available

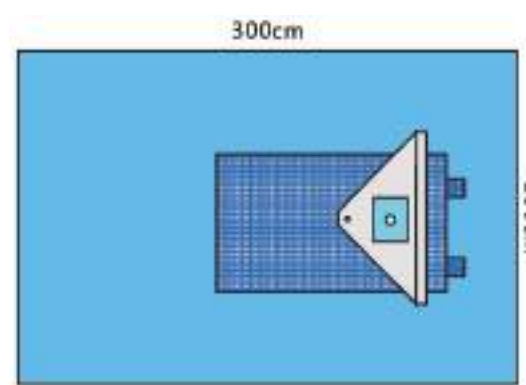

**Knee Arthroscopy Drape**

| Specification          | Size(cm)  | Qty | Material     |
|------------------------|-----------|-----|--------------|
| Knee Arthroscopy Drape | 200x300cm | 1pc | SMS<br>PE+PP |



Hole Size : 25x20cm  
Reinforced Area : 75x125cm  
Fluid Collection Pouch : 99x60cm  
\*Customized design is available

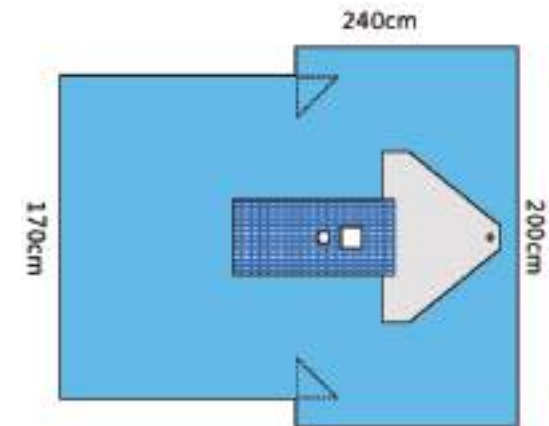

**T.U.R. Drape**

| Specification | Size(cm)      | Qty | Material     |
|---------------|---------------|-----|--------------|
| T.U.R. Drape  | 200/170x240cm | 1pc | SMS<br>PE+PP |



Reinforced Area : 75x35cm  
Fluid Collection Pouch : 80x55cm  
Square hole : 10x10cm  
Circle hole : 6cm  
\*Customized design is available

# DISPOSABLE SURGICAL PROTECTIVE PRODUCTS

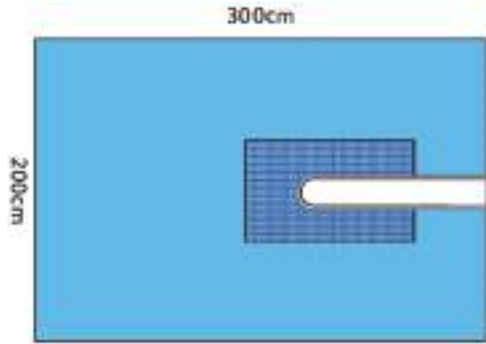

**U drape**

| Specification            | Size(cm)           | Qty | Material     |
|--------------------------|--------------------|-----|--------------|
| U drape                  | 200x300cm          | 1pc | SMS<br>PE+PP |
|                          | 200x320cm          |     |              |
|                          | U hole: 10x100cm   |     |              |
|                          | 15x100cm; 15x140cm |     |              |
| Absorbent Area: 60x120cm |                    |     |              |



SMS Reinforced Area  
Hole Size : 15x100cm /Reinforced  
Area : 60x100cm

\*Customized design is available

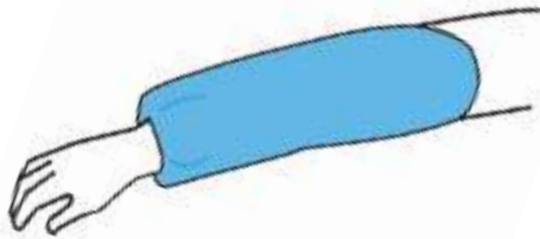

**Oversleeve**

| Specification | Size(cm)         | Qty  | Material |
|---------------|------------------|------|----------|
| Oversleeve    | 20x40an; 20x45cm | 2pcs | PE       |
|               | 22x40an; 22x60cm |      |          |
|               | 34x72cm          |      |          |

\*Customized design is available



**Bed Cover**

| Specification | Size(cm)  | Qty | Material                      |
|---------------|-----------|-----|-------------------------------|
| Bed Cover     | 100x210cm | 1pc | PP+PE/SMS+PE,<br>20gsm -80gsm |
|               | 80x210cm  |     |                               |

\*Customized design is available



**Back Table Cover**

| Specification    | Size(cm)  | Qty | Material            |
|------------------|-----------|-----|---------------------|
| Back Table Cover | 150x190cm | 1pc | PE+PP<br>PE+Viscose |

\*Customized design is available

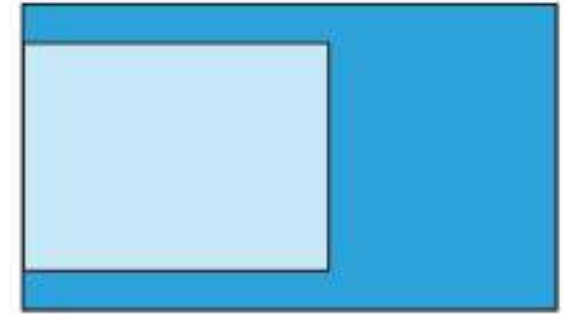

**Mayo Stand Covers**

| Specification     | Size(cm) | Qty | Material            |
|-------------------|----------|-----|---------------------|
| Mayo Stand Covers | 80x140cm | 1pc | PE+PP<br>PE+Viscose |
|                   | 80x145cm |     |                     |

\*Customized design is available

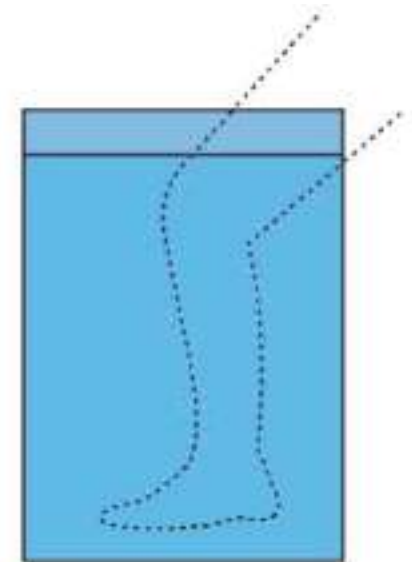

**Legging**

| Specification | Size(cm)                                 | Qty | Material       |
|---------------|--|-----|----------------|
| Legging       | 75x120 with 15cm cuff;                   | 1pc | PE<br>SMS,SMMS |
|               | 15x 76cm, stretclable, telescope folding |     |                |
|               | 23x100cm, stretclable, telescope folding |     |                |
|               | 30x120cm, stretclable, telescope folding |     |                |

\*Customized design is available

# DISPOSABLE SURGICAL PROTECTIVE PRODUCTS



Disposable Surgical Gown

| Specification            | Size(cm)                            | Color | Material         |
|--------------------------|-------------------------------------|-------|------------------|
| Standard Surgical Gown   | S, M, L, XL, XXL or as your request | Green | 30g-70g SMS      |
|                          |                                     | Blue  | SMMS, SMMMS      |
| Reinforced Surgical Gown |                                     | White | Non-woven fabric |

\*Customized design is available

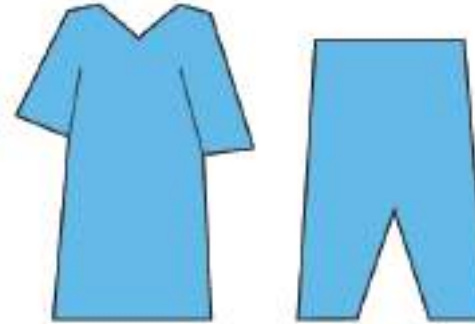

Disposable Patient Gown

| Specification           | Size(cm)                                     | Color   |
|-------------------------|--|---|
| Disposable Patient Gown | S, M, L, XL, XXL or as your request          | Dark blue   |
|                         |  | Light blue  |
|                         | Material                                     | Style   |
|                         | 30g- 70g SMS, SMMS, PP etc, non-woven fabric | Short sleeve/without sleeve; Neck and waist with ties |

\*Customized design is available

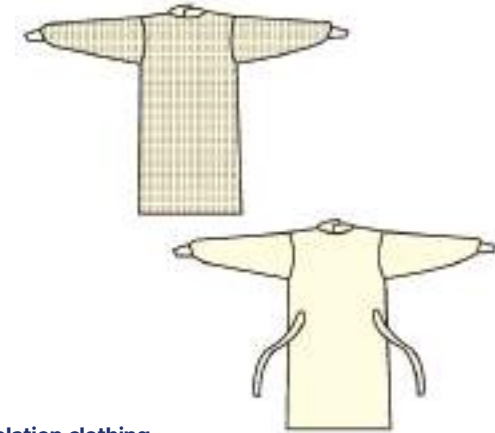

Isolation clothing

| Specification             | Size(cm)                               | Color         | Material |
|---------------------------|--|---------------|----------|
| Isolation clothing        | Regular, L, XL, XXL or as your request | Blue          | PE       |
| Reinforced Isolation Gown |  | Yellow, Green | PE+PP    |

\*Customized design is available



Disposable Visitor coat

| Specification           | Size(cm)                            | Color                                   |
|-------------------------|-------------------------------------|---|
| Disposable Visitor Coat | S, M, L, XL, XXL or as your request | White, Blue, etc                        |
|                         |                                     | Material                                |
|                         | Spunbonded PP non-woven             | Short sleeve/without sleeve with Popper |

\*Customized design is available

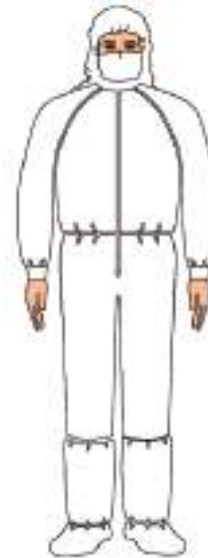

Protective Gown

| Specification              | Size(cm)                            | Color                         | Material                 |
|----------------------------|-------------------------------------|-------------------------------|--------------------------|
| Visitor Gawn/ Isolation Go | S, M, L, XL, XXL or as your request | Green, Blue, White, Pink, etc | PP or SMS, 16 gsm-45 gsm |

\*Customized design is available



Disposable Adult Bib

| Specification                    | Size(cm)   | Color                             |
|----------------------------------|--|-----------------------------------|
| Disposable Adult Bibs w/o Pocket | 50x3cm, 60x45cm, 64x36cm, 70x38cm                        | Green, Blue, White, Orange        |
|                                  |  | Material                          |
|                                  | 1-ply tissue+ 1-ply PE film; 2-ply tissue+ 1-ply PE film | Glue Lamination; Press Lamination |

\*Customized design is available

# DISPOSABLE SURGICAL PROTECTIVE PRODUCTS

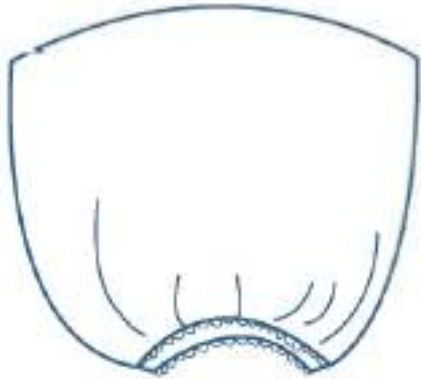

**Fluoroscopy Cover**

| Specification     | Size(cm)  | Qty | Material                          |
|-------------------|-----------|-----|-----------------------------------|
| Fluoroscopy Cover | 100x100cm | 1pc | PE film<br>25 inner (diameter)x30 |
| Fluoroscopy Cover | 80x90cm   | 1pc | PE film                           |

\*Customized design is available



**Medical Face Mask**

| Specification         | Size(cm)   | Color       | Material         |
|-----------------------|------------|-------------|------------------|
| Face Mask In Ties     | 9.5x17.5cm | Green,Blue, | PP,SMS,          |
| Face Mask in Ear Loop | or 9.5x18m | White,Pink, | Non-woven fabric |

\*Customized design is available



**Medical Cap**

| Specification | Size(cm)          | Color                         | Material                              |
|---------------|-------------------|-------------------------------|---------------------------------------|
| Clip Cap      | 18inch-24inch     |                               | Double or single elastic,<br>10-20gsm |
| Bouffant Cap  | 18inch-24inch     | Green,Blue,<br>White,Pink,etc | PP, 20g-30gsm                         |
| DoctorCap     | 12x64cm with ties |                               | PP, 20g-30gsm                         |

\*Customized design is available



**Medical Gloves**

| Specification                                | Size(cm)            | Material  |
|--|---------------------|---|
| Non-Sterile Medical Latex Examination Gloves | Size S, M, L, XL    | Latex, Powdered Free & Textured Finger,<br>Powdered & Smooth Surface  |
| Sterile Medical Latex Surgical Gloves        | Size 6.5, 7, 7.5, 8 | Latex, Powdered & Texture Surface,<br>Powdered Free & Texture Surface |

\*Customized design is available